

**INVESTIGATION, DESIGN, CONSTRUCTION AND TESTING
BROADBAND ANTENNA FOR RADIO TELESCOPE ARRAY
RECEIVER**



PREPARED BY: ONKGOPOTSE ISAAC MADIKWANE
UNIVERSITY OF CAPE TOWN
DEPARTMENT OF ELECTRICAL ENGINEERING

PREPARED FOR: PROFESSOR M.R. INGGS
UNIVERSITY OF CAPE TOWN
DEPARTMENT OF ELECTRICAL ENGINEERING

DATE: October 2006

DECLARATION:

1. I know that plagiarism is wrong. Plagiarism is to use another's work and pretend that it is one's own.
2. All the work of other people has been referenced.

Acknowledgements

I would first like to thank my supervisor for guiding me through the phases of this project as well as allowing me to use the microwave lab for conducting the tests. I'll also like to express my gratitude to Jon Ward and Rethabile Kutlwang for always letting me into the microwave lab at the time my student card was not active. Thanks also to Chris Wozniak for giving me access to the machine workshop for constructing the antenna. Finally, I would like to thank my sister, Kelebogile Madikwane, for continuous encouragement on this project.

Terms of reference

The instructions given by the supervisor are the following:

1. Investigate, design and construct broadband wire construction antennas for radio telescope array receiver.
2. These antennas should cover the band 1400 MHz to 1750 MHz.
3. Test the directive properties of the antennas and if possible, attempt to receive signals from strong sources such as satellites, the sun, moon, etc. by connecting to the Karoo Array Telescope (KAT) receiver.

Executive Summary

An antenna forms the interface between the free space and the transmitter or receiver. The choice of an antenna normally depends on factors such as gain and the bandwidth an antenna can offer. Signals from satellites travel thousands of kilometres to the earth and as the Friis equation (Appendix A) shows, they will only be detected as weak signals. Under these conditions, high gain antennas are required. The focus here is on low cost antennas and since the standard ones like the half wave dipole and the folded dipole cannot offer the much needed gain and bandwidth, the attention is thus shifted to the Yagi-Uda and the log-periodic dipole array antennas.

The gain of the Yagi antenna can be increased by approximately 1 dB for every additional director. However, properties such as the radiation pattern, sidelobe level and input impedance have to be taken into account. The question that comes to the fore is then; how many directors will suite an antenna with certain properties? To encompass all these factors, optimization software packages for the Yagi antennas have been developed over the years. Some of these software packages use the genetic algorithm to find the optimum length for the elements and their spacing. The algorithms employ the method of moments (MOM) based electromagnetic codes to compute current distributions on the antenna structure while taking into account the mutual coupling between elements. Yagi antennas have narrow bandwidths of the order of 2% when designed for high gain.

On the other hand, log-periodic dipole array (LPDA) antennas offer a wider bandwidth and can have gains as high as 10 dB. The dipoles are connected to the source using a twin transmission line in such a way that the phase is reversed at each connection relative to the adjacent elements. When connected this way, the bandwidths of the dipoles add-up to give a broader bandwidth. The transmission line is often replaced with a pair of metal boom structures separated by the dielectric material. R. L Carrel, who conducted intense studies on log-periodic antennas, has prepared curves and also devised the formulas for calculating parameters such as the required number of dipoles and their spacing, that are invaluable for the design of the LPDA.

Coaxial cables are used for feeding the outdoor antennas and we use either the radio frequency (RF) transformers or baluns for impedance transformation between the antenna and the cable. Mismatches form standing waves on the cable which can add-up constructively or destructively and hence distort or even wipe-off the signal of interest. The RF transformers and baluns also prevent cable radiation which has undesirable effects on the performance of an antenna.

If the main priority was the gain, then the Yagi antenna would be the best option. In the end, compromises had to be made between the gain and broader bandwidth by selecting the log periodic dipole array antenna. The other advantage of this antenna is that its input impedance can be set to the desired value by selecting the appropriate diameter for the dipole elements. Aluminium tubes and rods were chosen for the LPDA as it does not rust. The diameter of these rods and tubes were chosen so as to incorporate the compactness as well as the ease of assembly for the antenna elements. The dipole elements are attached to the boom structures by using pop rivets. Too thin dipole elements would result in high parallel rod feeder impedance. This would have adverse effect on the spacing of the booms and therefore violate our desired compactness.

Too much boom spacing would require a longer section of the coaxial cable insulation to be stripped. Signal power is lost due to cable radiation at high frequencies and imagine how much losses will be incurred if a longer section of the coaxial cable was stripped. For this LPDA, the cable used is RG-142B/U and has double shielding. The drawback of this cable is its stiffness but otherwise it has less signal attenuation. It was never going to be easy to connect the RF transformer directly to an antenna and so the coaxial cable was used again at the secondary side. This cable had to be kept short so that cable radiation could be minimized. The transformer used is TCN1-23 by Mini-Circuits® and is a surface mount miniature transformer. It was mounted onto the veriboard so as to facilitate the connections to the cables.

After going through all the exhaustive design and construction phases, what remained for the designer was to determine what has been achieved by conducting the tests. The first

test was determining the bandwidth of the LPDA. This test was done by measuring the scattering parameters of the antenna using the network analyzer. The power transmitted to an antenna was referenced to 0 dB and hence the plot displayed in the network analyzer represented the reflected power as a function of frequency. At the band where the antenna is operating, only a tiny fraction of power is reflected back to the analyzer indicating that most of the power has been radiated by the antenna. The antenna covers frequencies of 1.46 GHz to 1.77 GHz as indicated by Figure 5.5.

The final test was determining the radiation pattern of the LPDA. To obtain a well defined radiation pattern, tests should be conducted inside the RF anechoic chamber. When the antenna is inside this chamber, it cannot be influenced by any surface or objects that can re-radiate electromagnetic energy. Since there was no chamber that could be used, there was an influence by some other surfaces resulting in distortion of the radiation pattern. The radiation pattern of the LPDA can be found in Figure 5.10. To conduct this test, a source of radiation was required and hence the half-wave dipole had to be built. It was situated in such a way that its polarization was the same as that of the LPDA in order to receive energy efficiently. As indicated by the radiation pattern, the LPDA is a directional antenna. In order to receive signals efficiently with this antenna, then it should be pointed directly to the transmitter.

Apart from the slightly reduced bandwidth of the LPDA, the objectives have been met. Corrections can be made to the bandwidth by replacing the rear dipoles with the slightly longer ones. This will ensure that the antenna starts to receive at frequencies of about 1.4 GHz.

Table of contents

Chapter 1: Introduction	1
1.1 Background to the study	1
1.2 Problems to be investigated	1
1.3 Purposes of the study	1
1.4 Limits or boundaries of the study	1
1.5 Scope of the thesis	1
1.6 The plan of development of the thesis	2
Chapter 2: Literature Review	3
2.1 Overview	3
2.2 Antenna parameters	3
2.2.1 Gain	3
2.2.2 Resonant frequency	3
2.2.3 Impedance	3
2.2.4 Bandwidth	4
2.2.5 Radiation pattern	4
2.2.6 Polarization	4
2.3 Types of antennas	4
2.3.1 Half-wave dipole	5
2.3.2 Folded dipole	5
2.3.3 Yagi-Uda	5-7
2.3.4 Log-periodic dipole array	7-10
2.4 Feeding an antenna	10-12
Chapter 3: Establishing the design requirements	13
3.1 Calculating the LPDA design parameters	13-14
3.2 Selection of the RF transformer	13
3.3 Choosing the connector	13

Chapter 4: Construction	15
4.1 Assembling LPDA elements	15-16
4.2 Attaching the RF transformer to the antenna	16
Chapter 5: Testing and evaluation	17
5.1 Determining the bandwidth of the LPDA.....	17-22
5.2 Testing for directivity	23
5.2.1 Equipment set-up	23-24
5.2.2 Radiation pattern results and interpretations.....	25-26
Conclusions	27
Appendices:	A
A: Useful formulas with some of them derived	A-C
B: Data sheet of TCN1-23	D-E

Chapter 1

1 Introduction:

1.1 Background to the study

The Karoo Array Telescope is testing some receiver hardware to cover the band 700 MHz to 1750 MHz. The objective is to investigate the low cost antennas and then decide on which is appropriate to cover this band of frequencies. The gain of an antenna determine the range over which it can operate and hence it is a major contributing factor too.

1.2 Problems to be investigated

The investigation will be on low cost wire antennas.

1.3 Purposes of the study

Having gained more insight on antennas, the remaining task will be to come up with an appropriate design for the allocated band.

1.4 Limits or boundaries of the study

1.4.1 Time

The time to undertake the studies on antennas and even learn to use some software developed for optimizing antennas like the Yagi-Uda would leave us with less time for constructing the chosen antenna.

1.4.2 Availability of materials

Some of the antennas are sophisticated and therefore their materials will have to be ordered and this could even be from outside South Africa. This is reason enough to narrow down the focus to antennas which will be easier to construct.

1.5 Scope of the thesis

This thesis gives a brief description on the standard antennas like the half wave dipole and the folded dipole. It shouldn't come as a surprise since these antennas are actually the building blocks for the Yagi – Uda and the log-periodic dipole array which are covered in much more detail here.

1.6 The plan of development of the thesis

We often hear people talking about parameters such as the gain, bandwidth, input impedance and radiation pattern of an antenna which get us thinking; what are really these? To instill a sense of confidence about these invaluable parameters, this thesis gives a brief description of each.

In order to keep-up with the specifications, the studies conducted were only on low cost wire construction antennas. The thesis continues with a review on standard antennas such as the half-wave dipole and folded dipole. It further proceeds to the gain and bandwidth enhanced antennas such as the Yagi-Uda and the LPDA. Keep in mind that antennas not covered here is because they are difficult to construct and hence not cost effective. In engineering terms, there are theorems such as the maximum power transfer and this theorem is a motivation to conduct studies on how to incorporate this feature to the antenna design. Consequently, studies were launched on RF transformers and baluns.

Having armed with the necessary information about antennas, what is left is to establish the design requirements. This phase is followed by the construction of the appropriate antenna. To determine whether the objectives have been met, tests were conducted on the constructed antenna.

Chapter 2

2.1 Overview

Antennas are amongst the devices that are at the heart of communication systems, being used to transceive radio signals. An antenna forms the interface between the free space and the transmitter or receiver. The choice of a particular antenna depends on factors such as gain, radiation pattern, polarization, bandwidth, resonant frequency and impedance. [1, 4]

2.2 Antenna parameters

In engineering terminology, we often hear people talking about things such as antenna gain, bandwidth, etc. It is hence important to give a brief description of what these really mean.

2.2.1 Gain

The gain of an antenna is usually given with reference to an isotropic radiator and expressed in units of dBi (decibels over isotropic). In practice, the gain is compared with the radiation from a single half-wave dipole fed with an equal amount of power since a perfect isotropic reference is impossible to build. [1, 4] In this case, units of measurement are dBd (decibels over dipole). High gain antennas are of first priority because they are able to receive even weaker signals.

2.2.2 Resonant frequency

Signals of different frequencies reach the antenna simultaneously and for it to be of any importance, it should be able to select only one frequency of interest at a time. That frequency is called the resonant frequency and it is achieved by the use of a tuned circuit at the receiver or transmitter. Antennas are only effective for a range of frequencies over which they can operate and this is determined by their physical length. [4]

2.2.3 Impedance

The input impedance of an antenna determines the amount of energy it can receive or transmit. Maximum power transfer will occur when the antenna is matched to the receiver or transmitter as in accordance with the maximum power transfer theorem. [6] Section 1.7 of a textbook for antennas by F. R Connor gives more details on the latter. Most of all, an antenna is connected to the load by a feeder (usually a coaxial cable) which is unbalanced. In consequence, the cable radiates and this affects the efficiency of energy transfer to or from the antenna. [1]

2.2.4 Bandwidth

The bandwidth of an antenna is the range of frequencies for which it is effective. Several techniques can be used to improve the bandwidth of an antenna. Tapering antenna elements is one of these techniques and it is the essential application in the log-periodic dipole antenna. Some other alternatives include using thicker wires and replacing wires with cages to simulate thicker wires. [4]

2.2.5 Radiation pattern

The radiation pattern of an antenna is the most important requirement since it determines the direction in which the signal is transmitted or received. [1] It is specified by the beamwidth and sidelobe level in the plane (vertical or horizontal) it is being measured.

2.2.6 Polarization

Polarization is the orientation of the electric field of the radio wave with respect to the earth's surface. The transmitting and receiving antennas should have the same polarization for efficient radiation.

2.3 Types of Antennas

Antennas can be classified either as omni-directional (radiates equally over all space) or directional (radiates more in a particular direction). The focus here will be only on low cost wire construction antennas starting with the fundamental ones (the half-wave dipole

and folded dipole). These two antennas are basically the building blocks for gain and bandwidth enhanced antennas such as the Yagi-Uda and the Log Periodic Dipole Array.

2.3.1 Half-wave dipole

The simplest efficient antenna is a half-wave dipole, consisting of two quarter wavelengths wires and centre fed. It has an input impedance of about 73Ω and the gain of 2.15 dBi. [1, 6] This gain is too low and hence limits the application of this antenna. It will work perfect over shorter distances for low power level radiations. The appendix (A.2) gives more emphasis on this. The other constraint on this antenna is its narrow bandwidth. Alterations have been made on it in order to have improved gain and bandwidth.

2.3.2 Folded-dipole

Just like the half-wave dipole, the folded dipole is omni-directional. It has an input impedance of 300Ω and hence can be driven from a 300Ω balanced line. [4] The other advantage is that its operating bandwidth is slightly greater than that of a half-wave dipole. [7]

2.3.3 Yagi-Uda Antenna

This antenna, named after its inventors, Yagi and Uda, consists of a reflector, driven element and one or more directors all fixed on a supporting boom. [1 to 3] The driven element is usually a folded dipole since it offers an improved bandwidth over a standard half-wave dipole antenna and moreover allows the antenna to be fed from a 300Ω balanced line. [3] As the name implies, directors guide the electromagnetic waves either away from or towards the driven element depending on whether it is transmitting or receiving. Since the gain is closely related to the directivity of an antenna, the addition of directors in front of this driven element will improve the gain of an antenna. Each director improves the gain by approximately 1 decibel (dB). [1, 5]

While in theory the gain can be infinitely increased by adding more directors, it's advisable not to use a large number of directors because they can diminish the

performance of the antenna. [5, 8] The parasitic elements (reflector and directors) tend to reduce the impedance of the folded dipole and this makes it easier for the antenna to be matched to standard transmission lines (e.g. the $50\ \Omega$ coaxial cable). [7, 8] A schematic diagram of a Yagi antenna is shown in figure 2.1.

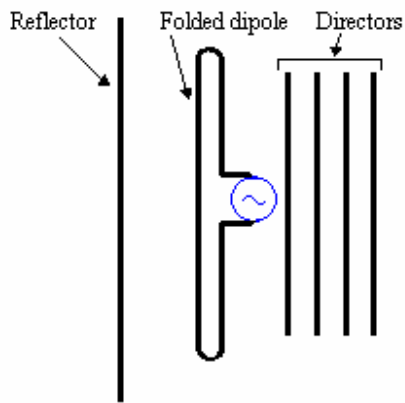

Figure 2.1 A six-element Yagi antenna

Yagi-Uda antennas have narrow bandwidths of the order of 2% when designed for high gain. [7, 8] The formula for calculating the percentage bandwidth can be found in the appendix (A.3). If a broad bandwidth is required, then the designer has to settle for a compromise between the gain and bandwidth. Digital computers and antenna design software packages made the design and analysis of antennas much easier. It is through the use of the latter that designers manage to obtain appropriate parameters for antenna design. An increased bandwidth could be achieved by designing directors for the upper end of the required band and the reflector for the lower end of the band in Yagi-Uda antennas. [8]

“Optimization of Yagi-Uda antennas is a challenging design problem, since the antenna characteristics such as gain, input impedance, maximum sidelobe level etc., are known to be extremely sensitive to the design variables viz., element lengths and their

spacing.”[12] Several techniques like the evolutionary algorithm (EA), genetic algorithm (GA) and computational intelligence (CI) are used for optimizing these antennas. The CI algorithm introduced by Neelakantam V. Venkatarayalu and Tapabrata Ray begins by initializing a set of solutions obtained through the method of moments-based numerical electromagnetic code (NEC-2). [12] This method is capable of computing current distributions on the antenna structure while taking into account physical phenomena such as mutual coupling between elements. [12] It is a powerful code that enables a designer to simulate the properties of antennas like the gain, radiation pattern and the input impedance. Yagi elements are normally aluminum tubes or rods (could be square or round). The reflector spacing from the dipole ranges from 0.15λ to 0.2λ (λ is the wavelength) and is about 0.5λ long. [2, 6] The directors are usually 0.4λ to 0.43λ long and are placed about 0.1λ apart for maximum gain whilst the resonant length of a dipole is made 0.46λ long. [6, 7] These may be mounted insulated or un-insulated above or through the boom. [2]

2.3.4 Log Periodic Dipole Array (LPDA) Antenna

The broadband properties of this antenna make it a better choice for operation over a wider frequency range. It consists of small closely spaced half-wave dipoles. The length ratio between adjacent dipoles is a constant (τ) and the ratio of element spacing to twice the next larger element length is a constant (σ). [8] The dipoles are connected to the source using a twin transmission line in such a way that the phase is reversed at each connection relative to the adjacent elements. [7, 8] Figure 2.2 shows a simplified way of connecting the dipoles to a transmission line. Each dipole is effective over a narrow band of frequencies determined by its length. When they are all connected to the twin transmission line, their narrow bandwidths add up to give a wider bandwidth. The length ratio (τ) is chosen such that the antenna’s performance will be uniform over the whole bandwidth. The shortest dipole corresponds to the highest frequency band and the longest dipole to the lowest frequency band of an antenna. A number of the dipoles whose frequency bands are in the vicinity of the selected resonant frequency will also be active. The bandwidth ratio (B) is given approximately by $B = B_s/B_{ar}$ where B_s is the structure Bandwidth and B_{ar} is the bandwidth of the active region. [8]

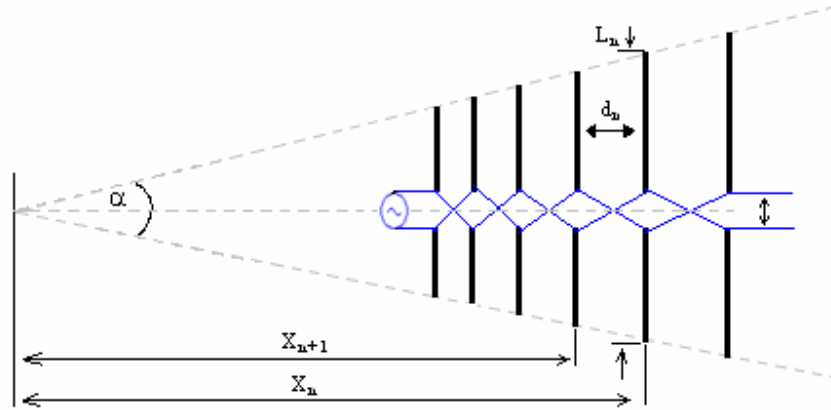

Figure 2.2 Log periodic dipole array antenna

$$\tau = \frac{X_{n+1}}{X_n} \quad n = 1, 2, 3, \dots, N \quad (2.1)$$

$$\sigma = \frac{d_n}{2L_n} \quad (2.2)$$

The angle α which is very important for the calculation of B_{ar} is given by

$$\alpha = \text{Tan}^{-1}\left(\frac{1-\tau}{4\sigma}\right) \quad (2.3)$$

and derived in appendix (A.4)

The length (L) between the longest and shortest element is (appendix A.5)

$$L = \frac{\lambda_{\max}}{4} \left(1 - \frac{1}{B_s}\right) \cot(\alpha) \quad (2.4)$$

The bandwidth of the active region (B_{ar}) is

$$B_{ar} = 1.1 + 7.7(1 - \tau)^2 \cot \alpha \quad (2.5)$$

The number of dipoles required is obtained from the formula

$$N = 1 + \frac{\log B_s}{\log(\frac{1}{\tau})} \quad (2.6)$$

The analysis of log periodic dipole arrays shows that the characteristic impedance of the elements varies with frequency and thus, an empirical formula (2.7) for calculating the average characteristic impedance has been devised. [5, 7] To find out more on this, it is worth your while to study the first section of chapter five of [5].

$$Z_a = 120 \left(\ln \frac{h}{a} - 2.25 \right) \quad (2.7)$$

h is the half-length of the longest dipole
 a is the radius of the dipoles.

The dipoles are mounted on two boom structures which in essence are transmission lines since the dipoles are mounted on them un-insulated. As a consequence, the booms have to be isolated from each other by using dielectric spacers. [1] The impedance of this parallel rod feeder can be obtained by using equation (2.8).

$$Z_0 = \frac{R_0^2}{8\sigma' Z_a} + R_0 \sqrt{\left(\frac{R_0}{8\sigma' Z_a} \right)^2 + 1} \quad (2.8)$$

R_0 is the input impedance of the LPDA and can be found by using equation (2.9).

$$R_0 = \frac{Z_0}{\sqrt{1 + \frac{Z_0}{4\sigma' Z_a}}} \quad (2.9)$$

where σ' (mean spacing factor) is $\frac{\sigma}{\sqrt{\tau}}$

The center-to-center distance (S) between the booms is obtained from (2.10)

$$S = \left(\frac{\text{diam}}{2}\right) \times 10^{Z_0/276} \quad (2.10)$$

where diam is the outer diameter of the booms (in same units as S).

Figure 2.3 shows the curves devised by Carrel and these give a very good estimate of the gain for any particular LPDA design.

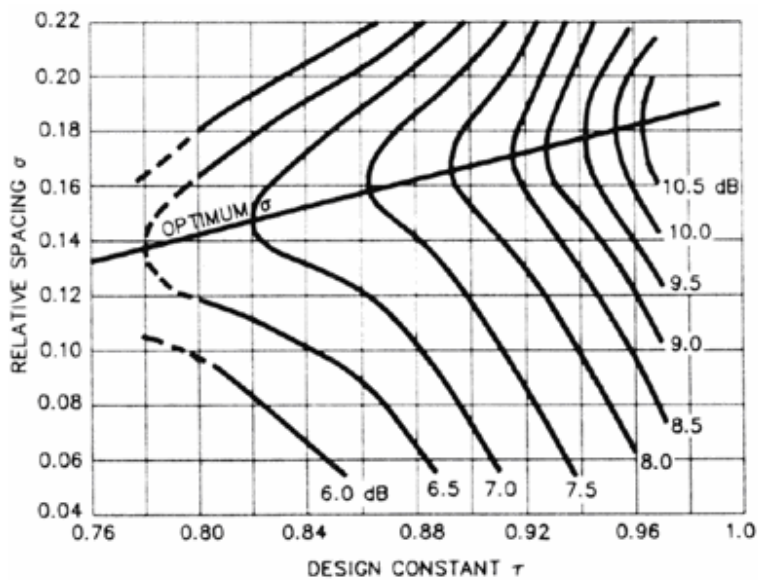

Figure 2.3 Design curves relating τ and σ to gain

2.4 Feeding an antenna

Coaxial cables are preferred to other transmission lines for the following reasons.

1. Their characteristic impedance (Z_0) does not depend on the physical length but rather on the size and spacing of the conductors and the type of dielectric used between them. [9]

$$Z_0 = \frac{138}{\sqrt{\epsilon}} \log\left(\frac{D}{d}\right) \quad (2.11)$$

D = inner diameter of cable shield
d = diameter of center conductor
ε = dielectric constant

2. The shielding effectiveness

3. Their flexibility

The drawback of a coaxial cable is that it is an unbalanced transmission line. When it is connected directly to an antenna, the cable radiates and hence distorts the radiation pattern of an antenna. This is because the alternating current on a conductor is not spread throughout the conductor but is strongest at the surface and decays exponentially at points further into the conductor. [10] This is called the skin effect and Figure 2.4 shows the current distribution in the coaxial cable. I_1 is the current on the surface of the center conductor and it is equal and opposite to I_2 which is distributed in the inner surface of the outer conductor. I_2 divides into I_3 (which is radiated by the antenna) and I_4 (which flows back on the outside of the outer conductor causing the cable to radiate). [11]

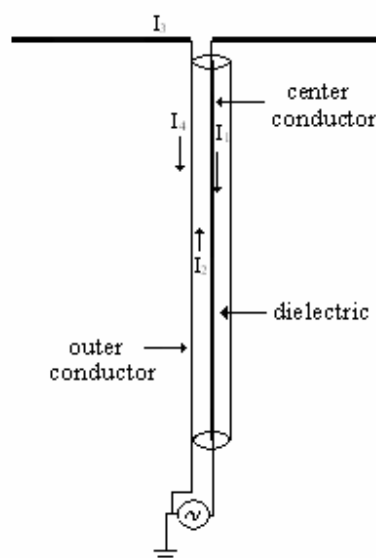

Figure 2.4 Current distribution in the coaxial cable [11]

Cable radiation is avoided by connecting a coaxial cable to a balun or RF transformer which in essence isolates the cable from the antenna. This setup results in balanced output opposite currents and hence nulls out the field created in the cable. The widely used baluns are the 1:1 and 4:1 current baluns. Figure 2.5 shows a 1:1 current balun which finds widespread application at lower frequencies. [13]

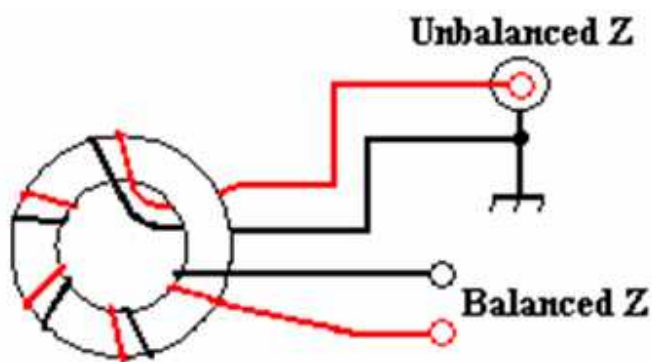

Figure 2.5 1:1 Ferrite core current balun [13]

The coaxial cable that is used for the 1:4 transmission line current balun is RG-62 and has an impedance of 95 Ω . We would actually prefer to use the 100 Ω transmission line but RG-62 is the standardized one.

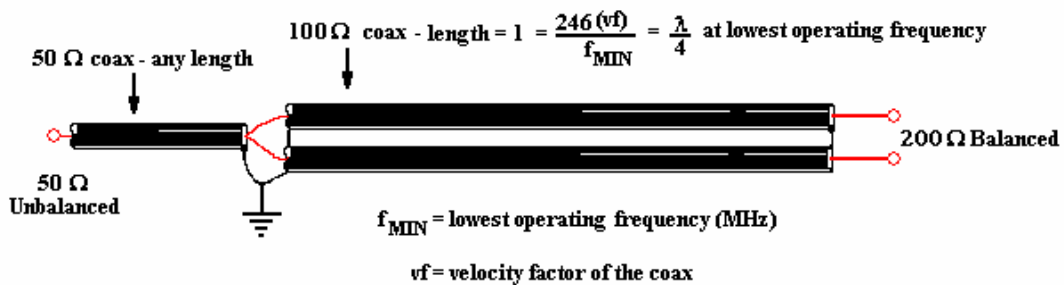

Figure 2.6 4:1 Transmission line current balun [13]

Chapter 3

3.1 Calculating the LPDA design parameters

In order to cover the band 1400 MHz to 1750 MHz, one can use an LPDA or the Yagi antennas each assigned a narrow slot to operate on. Since the specifications are that we require a broadband antenna, then the focus will only be on the LPDA.

The band 1400 MHz to 1750 MHz has the longest wavelength (λ_{\max}) of 0.214 m. As a consequence, the longest dipole in the array will be 0.107 m long. If we choose the diameter of 10 mm for the dipoles, then from (2.7), Z_a becomes 14.43 Ω . The estimated gain of our LPDA is 10 dB for σ and τ of 0.20 and 0.985, respectively (see figure 2.3). If we choose the LPDA input impedance (R_0) of 50 Ω , then from (2.8), the parallel rod feeder impedance (Z_0) is approximately 223 Ω . Higher input impedance would have adverse effect on the spacing of the booms.

The chosen σ and τ values yield the virtual subtended angle (α) of 3 degrees in (2.3). We achieve a bandwidth ratio ($B = 1750 \text{ MHz}/1400 \text{ MHz}$) of 1.25 and (2.5) gives B_{ar} as 1.36. Having obtained B and B_{ar} , we get B_s of 1.70. This LPDA antenna should have 14 elements as indicated by (2.6). Table 3.1 gives some of the parameters for our LPDA antenna.

Dipole length (L_n)	Dipole spacing ($d_{n,n+1}$)
$L_1 = 0.107$	$d_{1,2} = 0.043$
$L_2 = 0.103$	$d_{2,3} = 0.041$
$L_3 = 0.099$	$d_{3,4} = 0.040$
$L_4 = 0.095$	$d_{4,5} = 0.038$
$L_5 = 0.091$	$d_{5,6} = 0.036$
$L_6 = 0.087$	$d_{6,7} = 0.035$
$L_7 = 0.083$	$d_{7,8} = 0.033$
$L_8 = 0.080$	$d_{8,9} = 0.032$
$L_9 = 0.077$	$d_{9,10} = 0.031$
$L_{10} = 0.074$	$d_{10,11} = 0.030$
$L_{11} = 0.071$	$d_{11,12} = 0.028$
$L_{12} = 0.068$	$d_{12,13} = 0.027$
$L_{13} = 0.065$	$d_{13,14} = 0.026$
$L_{14} = 0.062$	

Table 3.1 Dipole lengths and spacing

3.2 Selection of the RF transformer

RF transformers, just like baluns are used for impedance transformation and preventing unbalanced currents from flowing in the coaxial cables. The type of transformer chosen for this design is the TCN1-23 by Mini-circuits®. It is a 1:1 miniature transformer and its features, specifications and performance data can be found in appendix B.

3.3 Choosing the connector

The connector has to be matched to the cable and this means that the connector's impedance should be 50 Ω . The type of connector chosen is SMA male connector.

Chapter 4

4.1 Assembling LPDA elements

Pop riveting the dipole elements to the booms offers quick assembly given the time constraint one is working under. There are different types of pop rivets and the choice normally depends on how much strength is desired and whether the fastenings should be water tight. For this application, the open-end rivets will be used as the materials to be fastened do not have high strength requirements.

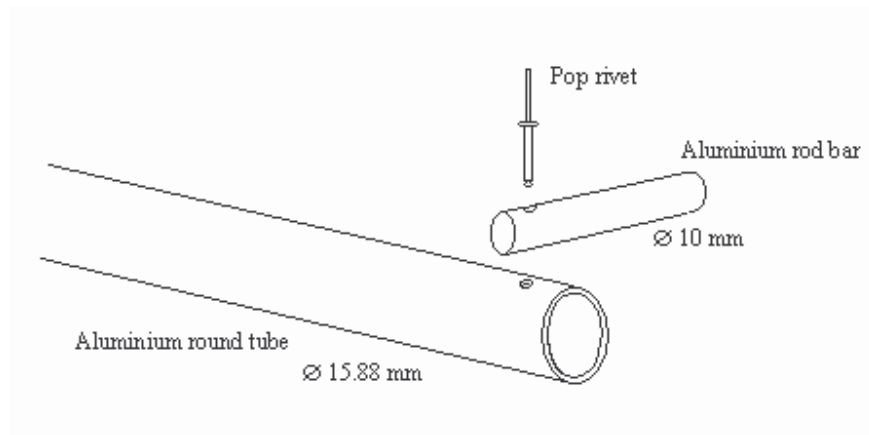

Figure 4.1 Fastening the dipole elements to the boom

The center to center spacing between the booms as indicated by (2.10) is 51 mm. The dielectric material should be made 35 mm long. This also places a restriction on the length of screws required for fastening the booms to the dielectric material. A length of 15 mm can be chosen for each screw so that there is a clearance of 5 mm between the screws.

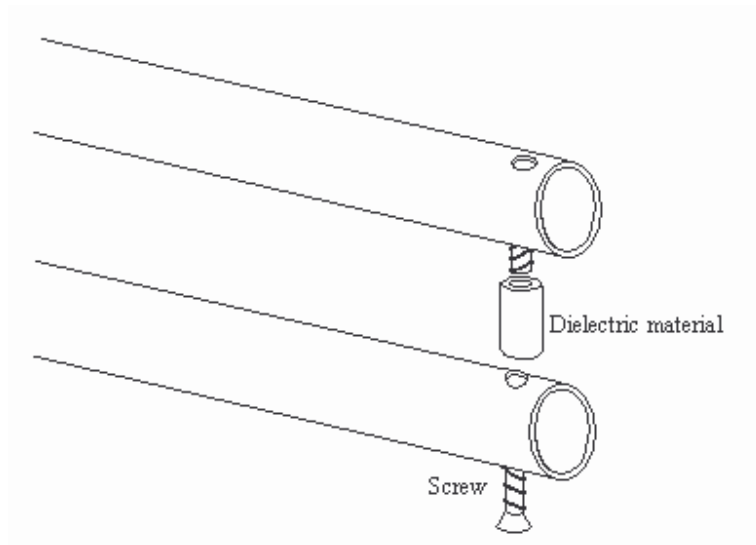

Figure 4.2 How to join the booms together

4.2 Attaching the RF transformer to the antenna

TCN1-23 is a surface mount transformer and for its size, great care has to be taken when connecting it. Figure 4.3 shows how this can be done.

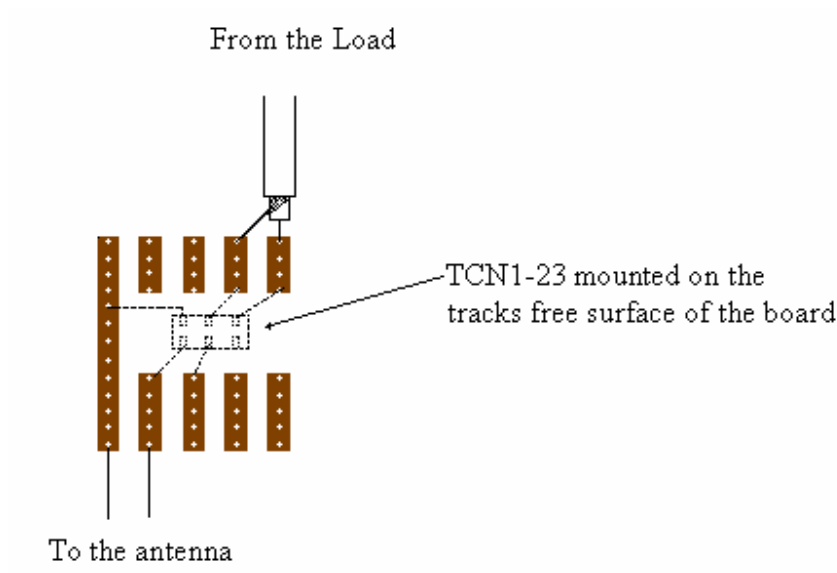

Figure 4.3 How to mount the TCN1-23 on the veriboard

Chapter 5

5.1 Determining the bandwidth of the LPDA

Figures 5.1 and 5.2 indicate the bandwidth of the LPDA. The antenna starts to radiate at a frequency of about 1.46 GHz and stops its radiation at around 1.75 GHz. This gives a bandwidth of about 300 MHz. The figures were obtained by using E5071B network analyzer. The antenna was connected to port 1 of the network analyzer and then the scattering parameter (S11) was measured.

The power sent out through port 1 was referenced to 0 dB. There are some losses of approximately 2.5 dB for frequencies 1 GHz to 1.46 GHz. As specified in the data sheet, TCN1-23 has an insertion loss (Appendix A.6) of about 1 dB which accounts for the losses incurred prior to antenna radiation. The remaining 1.5 dB loss could be due to our cabling system.

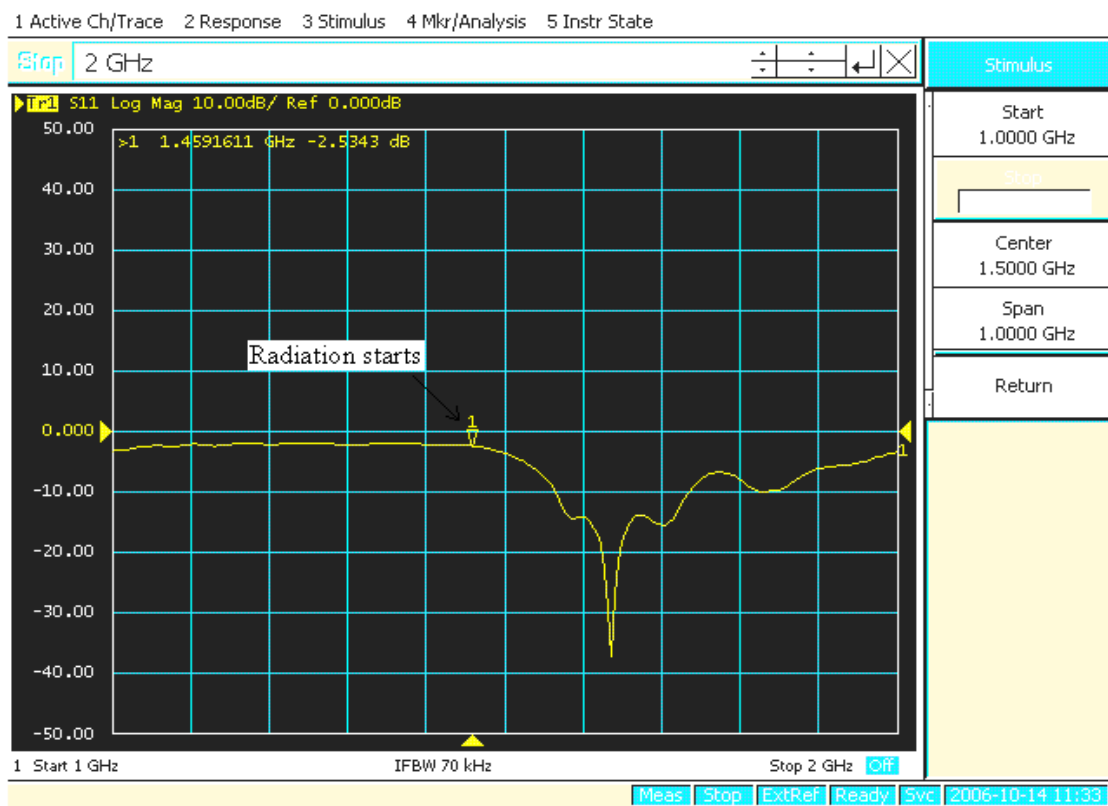

Figure 5.1 Start frequency for antenna radiation

S11 (in dB) can be expressed as the difference between the reflected power (dB) and incident power (dB). To recap, an antenna can be used for both transmitting and receiving. Consequently, an antenna should radiate most of the power transmitted to it at the band it has been designed to operate at. In essence, S11 is just a measure of how much power gets reflected back to port 1 since the incident power is referenced to 0 dB. At frequencies where the antenna should operate, a tiny fraction of power is reflected back to port 1 as indicated by the low power levels.

Ideally, the antenna characteristics should be flat at its band of operation but this is not always the case in reality. For our situation, this could be attributed by the fact that the length to diameter ratio for the dipole elements was not constant throughout. This is usually the case for practical designs because of the need to minimize costs.

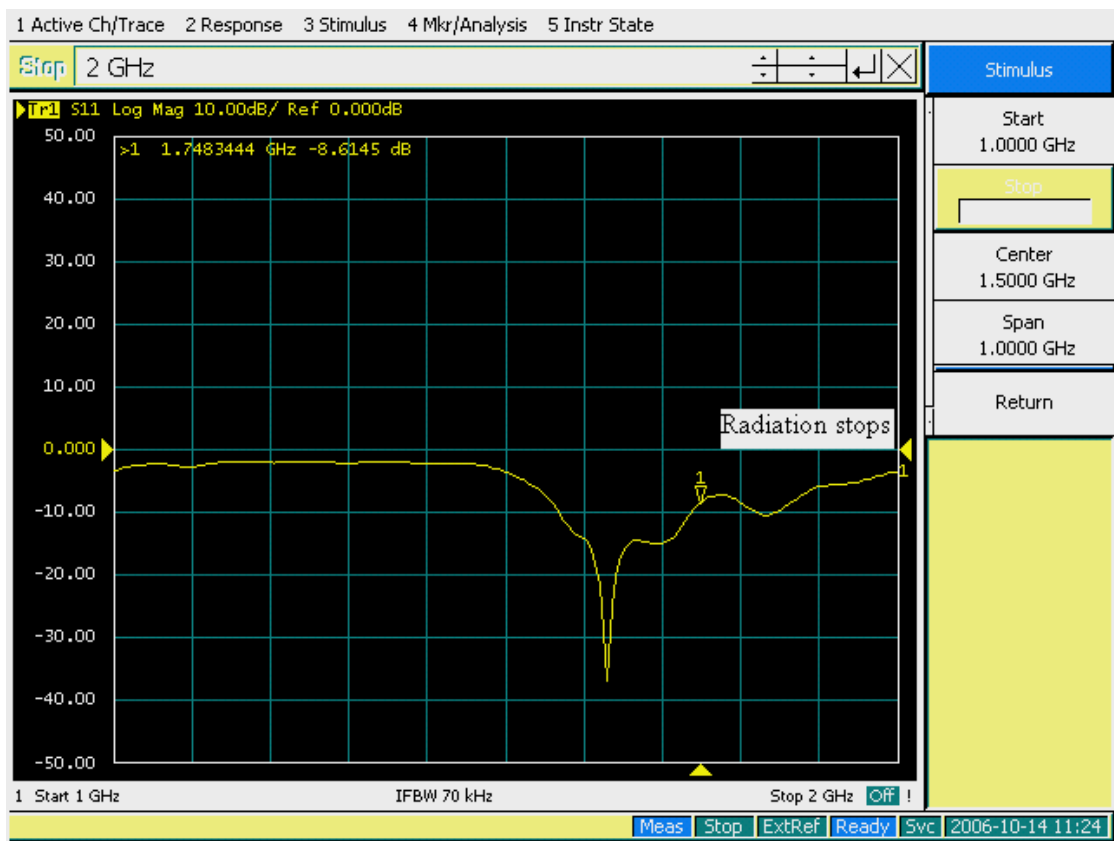

Figure 5.2 Stop frequency for antenna radiation

There is one other thing that is quite visible about the response of this antenna. It should start to radiate at a frequency of 1.4 GHz but that is not the case as indicated in Figures 5.1 and 5.2. The response can be rectified by lengthening the dipoles at the rear end of an antenna. As I was conducting the tests, I also noticed that covering the copper tracks of the veriboard with an insulator raises the power level at the radiation band. This made me ponder a lot and at last, one answer came to my mind. The cable attached to the secondary side of the RF transformer is joined directly to an antenna and as the antenna radiates, this section of the cable also radiates. A fraction of the reflected power is lost at the copper tracks when the secondary section of the cable radiates since they are not shielded. The concept of cable radiation was introduced in chapter 2.4 and therefore the reader is urged to visit this section for clarity. Figure 5.3 shows the updated response of our antenna.

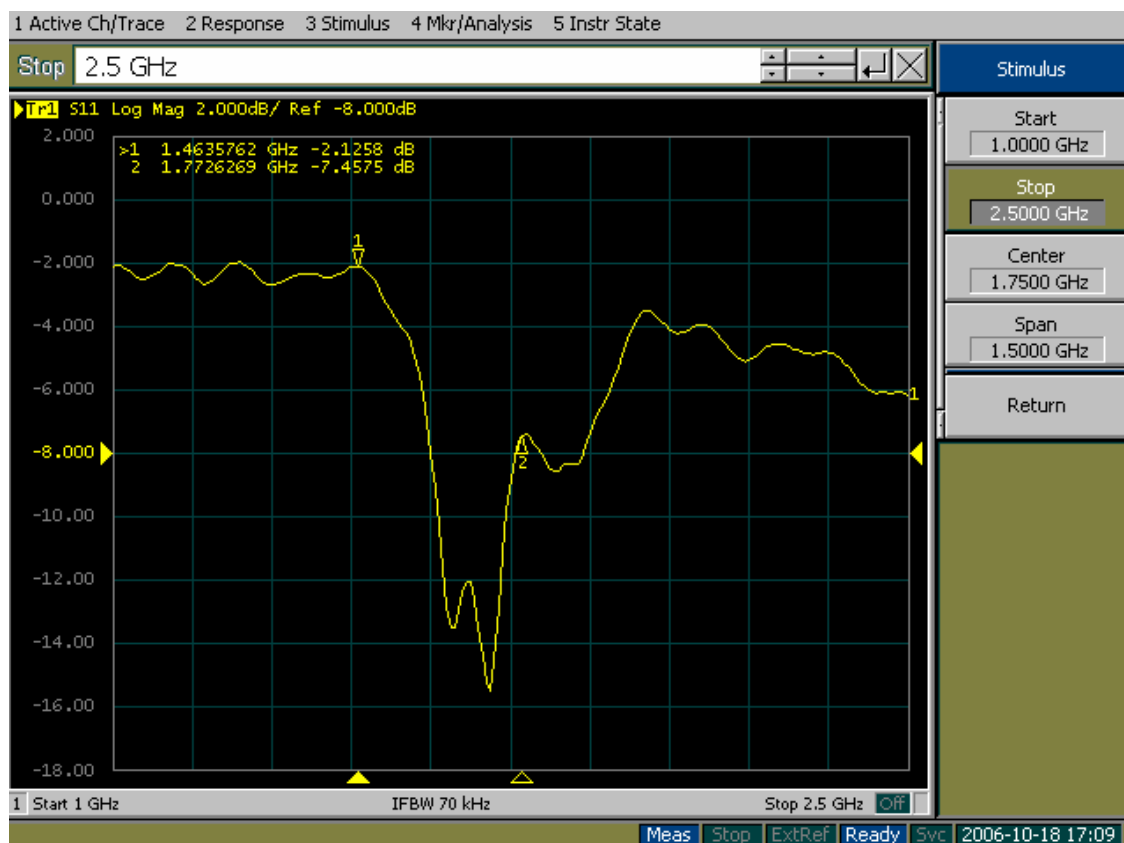

Figure 5.3 Part of the designated bandwidth (frequencies 1.46 GHz to 1.77 GHz)

The wooden board shown in Figure 5.4 has modified the response of our LPDA. Apparently, power radiated from the copper tracks gets trapped between the wooden board and veriboard. Consequently, a fraction of that gets re-radiated into the copper tracks and hence reduction in undesired radiation. Well, the board also gives support to the soldered cables which would otherwise be prone to breakages.

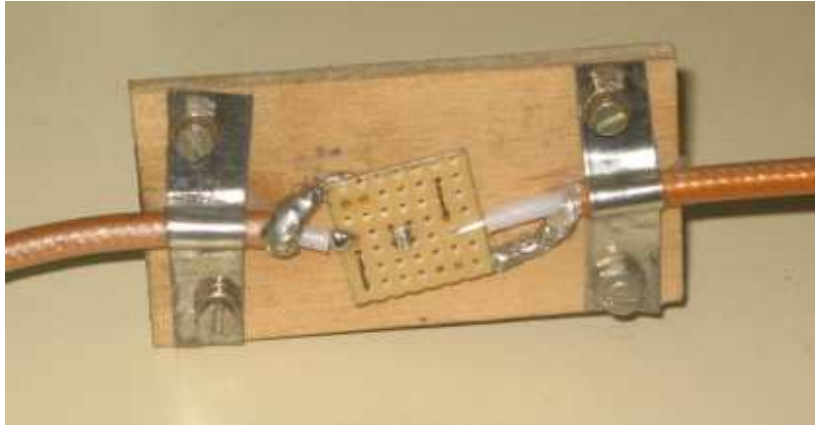

Figure 5.4 Copper rails insulation as well as support for the RF transformer and cables

There was a growing concern about the response of this LPDA particularly with the radiation occurring right after its designated high frequency band. At last, I remembered that the number of dipoles obtained using (2.6) was an irrational number which was then rounded up to 14. The number of dipoles was trimmed down to 13 and the results were really amazing. The undesired radiation that was just next to the LPDA's designated band disappeared as revealed by Figure 5.5. Figure 5.6 shows the LPDA under bandwidth test.

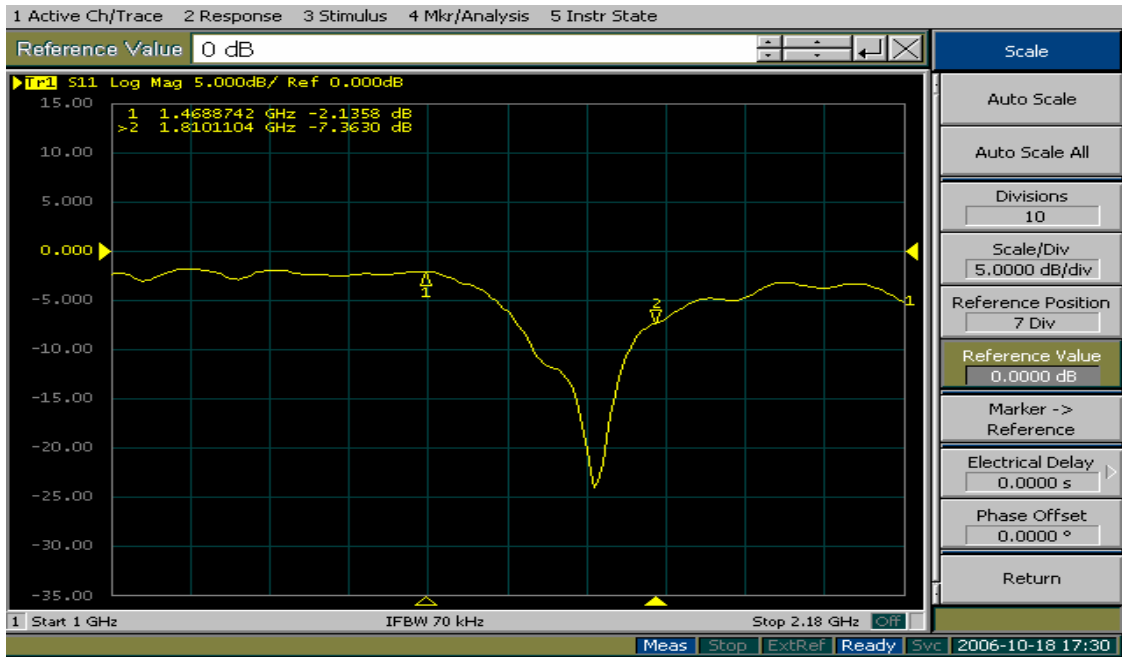

Figure 5.5 Response after removing the 14th dipole



Figure 5.6 LPDA under bandwidth test

When the frequency span of network analyzer is increased, some anomalous frequencies are observed at around 3 GHz. This arises because the LPDA has a very low input impedance of 50 Ω . [15] For this design, the input impedance of 50 Ω was selected because high impedance would require large spacing of the booms. The end-result would be that a longer section of the coaxial cable that joins the RF transformer to the antenna has to be stripped. Stripping a longer section of the cable would result in too much power loss in the cable.

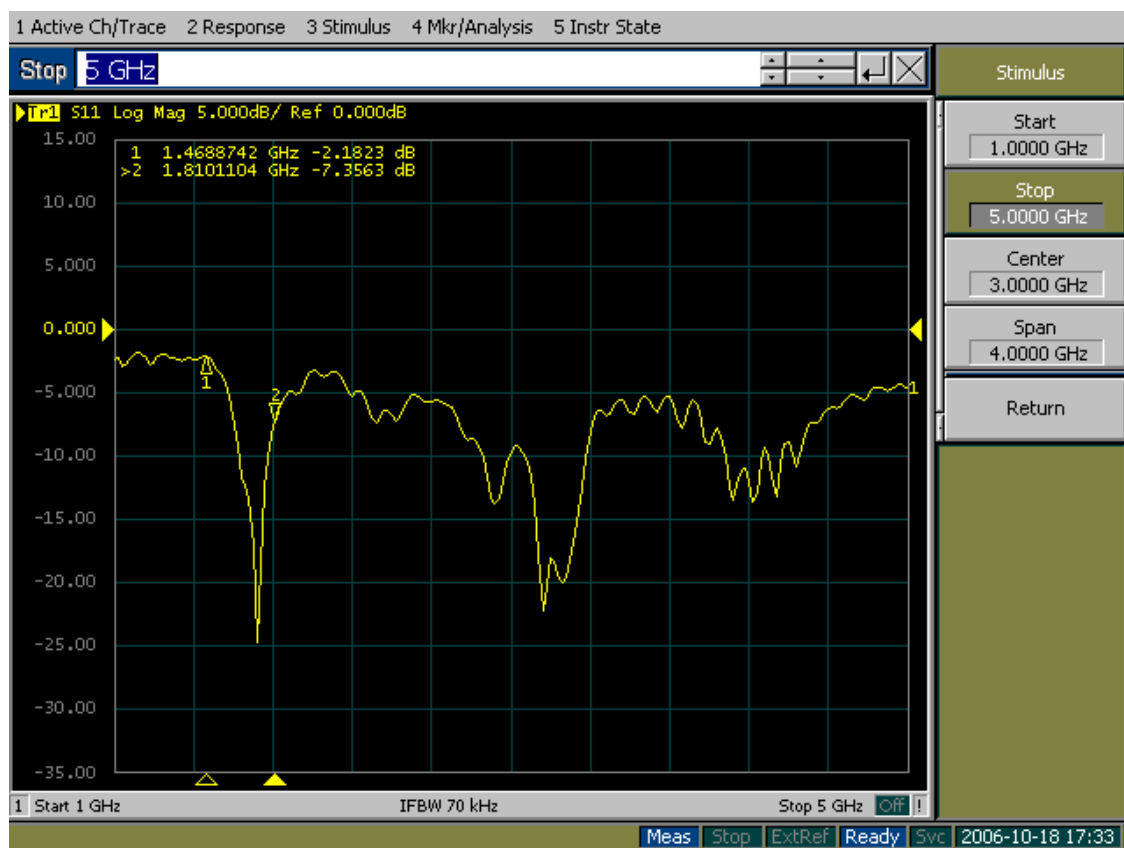

Figure 5.7 Anomalous frequency observed at around 3 GHz

5.2 Testing for directivity

In order to test for the directivity of the LPDA, a half-wave dipole was constructed. This antenna was designed to operate at a frequency of 1.65 GHz which is within the bandwidth of our LPDA. In this scenario, the half-wave dipole acts as a transmitter while the LPDA is a receiver. By rotating the LPDA through 180 degrees in 10 degree steps and recording the received power at each instance, one is able to determine the directivity. The recorded powers are then normalized to the maximum value and plotted to show the relative variation of the received power in dB.

5.2.1 Equipment set-up

The half-wave dipole was connected to the hp 8350B sweep oscillator calibrated to radiate 16 dBm of power at a frequency of 1.65 GHz. On the other hand, the LPDA was connected to the HEWLETT-PACKARD 435A power meter. The antennas were placed a distance of 1.1 metres apart. With the reading on the power meter quite susceptible to variations due to the radiated power from other sources, four sets of results were obtained and their average was computed. This was done so as to narrow down the error margin which would vastly affect our results.

The LPDA had to be manually rotated as there was nothing else that could be used for carrying out this process. When the feed-point of the LPDA is directly facing the half-wave dipole, the angle is defined to be 90 degrees. Rotating the antenna from this position to the right by 90 degrees gives the 0 degree position and the 180 degrees position is obtained if rotation is to the left. Bear in mind that the recorded values are the direct values from the power meter. When the sweep oscillator was off, the power meter measured the power of about 0.14 μ W. Consequently, the received power for each instance should be less by the latter amount.

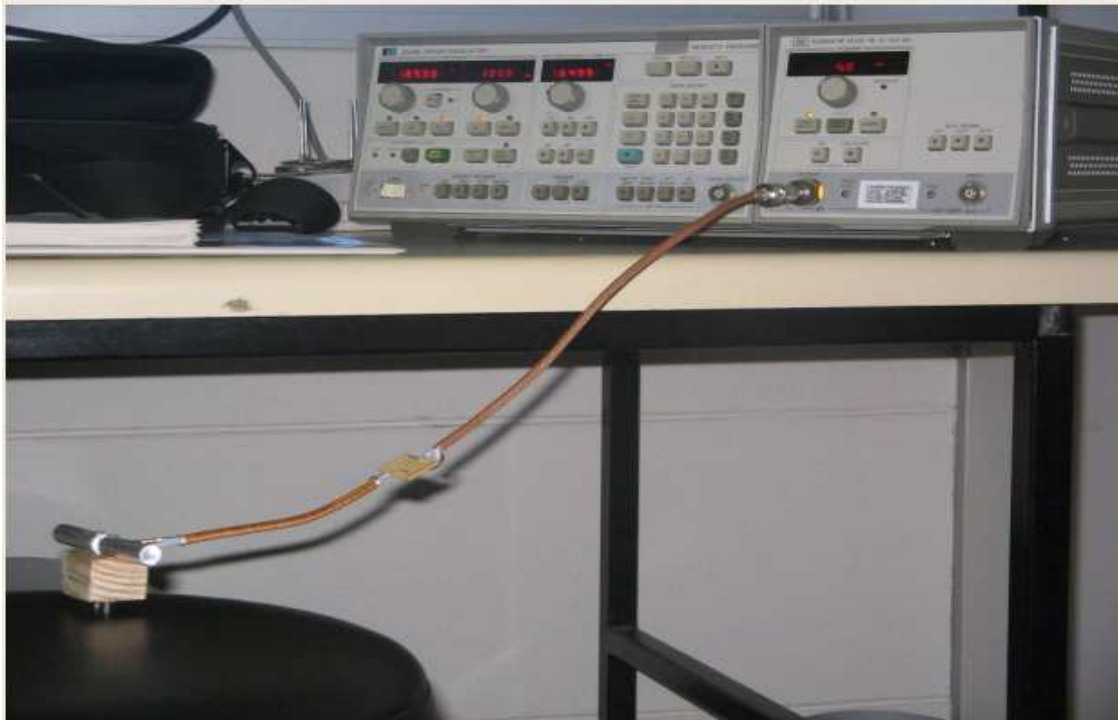

Figure 5.8 Radiating power through the half-wave dipole



Figure 5.9 LPDA connected to the power meter

5.2.2 Radiation pattern results and interpretations

Table 5.1 Received power as a function of angle

Degrees	Power (μW)				Average power(μW)	Power(dB)
0	0.58	0.62	0.60	0.52	0.44	-3.58
10	0.64	0.50	0.54	0.55	0.418	-3.8
20	0.43	0.46	0.48	0.46	0.318	-4.99
30	0.69	0.68	0.70	0.64	0.538	-2.71
40	0.64	0.56	0.66	0.62	0.48	-3.2
50	0.76	0.64	0.70	0.74	0.57	-2.45
60	0.80	0.71	0.90	0.94	0.698	-1.57
70	0.82	0.73	1.05	0.99	0.758	-1.22
80	1.15	0.77	1.20	1.10	0.915	-0.4
90	1.25	0.82	1.30	1.20	1.003	0
100	1.10	0.92	0.15	1.06	0.668	-1.77
110	0.8	0.85	0.98	0.95	0.755	-1.23
120	0.83	0.68	0.92	0.93	0.7	-1.56
130	0.75	0.66	0.71	0.73	0.573	-2.44
140	0.64	0.53	0.68	0.60	0.473	-3.27
150	0.70	0.65	0.67	0.68	0.535	-2.73
160	0.40	0.43	0.49	0.44	0.3	-5.24
170	0.60	0.58	0.64	0.57	0.458	-3.4
180	0.52	0.64	0.60	0.55	0.438	-3.6

The radiation pattern shown in Figure 5.10 indicates that the LPDA is a directional antenna. This implies that the antenna will receive efficiently for smaller angles of misalignment with the transmitter. This is always the case with high gain antennas. The LPDA has minor sidelobes and virtually no radiation at angles of 20 and 160 degrees.

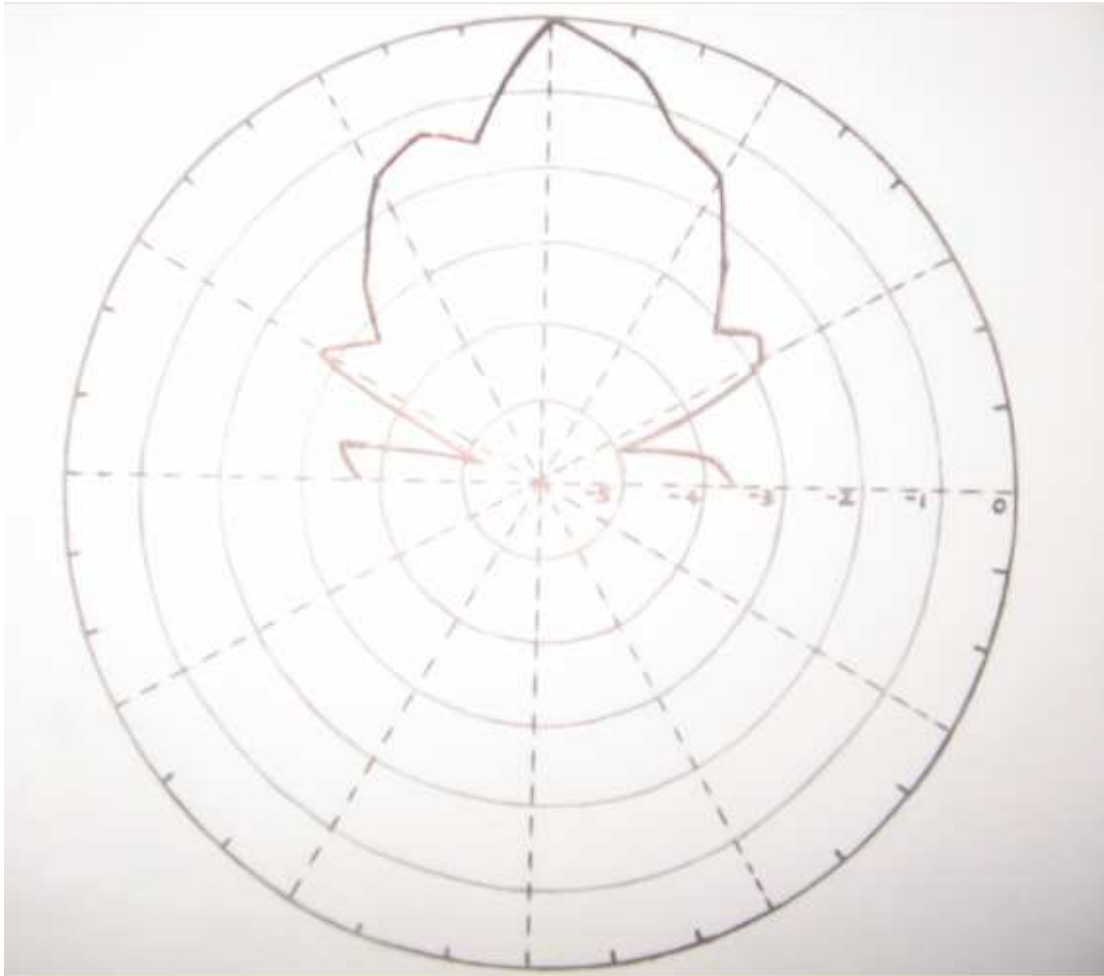

Figure 5.10 The radiation pattern of LPDA

Conclusions

The log-periodic dipole array remains the simplest antenna with reliable bandwidth and gain estimates. One can design a very good LPDA without having to simulate this antenna using the sophisticated software packages. The LPDA was hence constructed and tested.

The results indicated the slight increase in frequency at which the LPDA starts to operate. Since the operating frequency of an antenna depends on the length of dipoles, the rear most dipole could be replaced with a slight longer dipole so that the antenna starts radiating at a frequency of 1.4 GHz. The initial bandwidth test results also indicated an increase in high frequency band for the LPDA. Consequently, the front dipole was removed in order to limit the frequency response of the antenna to about 1.76 GHz. The directivity test results showed that the LPDA is a directional antenna.

There was not enough time to attempt to receive signals from satellites by connecting the antenna to the KAT receiver. This attempt might be the possible step for future research. Another interesting research would be cascading two of these antennas to try and obtain the antenna with increased beamwidth while having the broadband properties too.

References:

- [1].G. R. Jessop, CEng, MIERE, G6JP, VHF/UHF manual, fourth edition, Radio Society of Great Britain
- [2].The ARRL Handbook for Radio Amateurs
- [3].Yagi antenna – Wikipedia, the free encyclopedia. [Online]. Available: http://en.wikipedia.org/wiki/Yagi_antenna
- [4].Antenna (radio) - Wikipedia, the free encyclopedia. [Online]. Available: http://en.wikipedia.org/wiki/Antenna_%28electronics%29
- [5].M. T. Ma, Theory and application of antenna arrays.
- [6].F.R Connor, Ph.D., B.Sc.(Eng) Hons, A.C.G.I., C.Eng., M.I.E.R.E., M.Inst.P, Antennas
- [7].W. L. Weeks, Professor of Electrical Engineering, Purdue University, Antenna Engineering
- [8].A.W. Rudge, K. Milne, A. D. Olver, P. Knight, The Handbook of Antenna Design, Volumes 1 and 2
- [9].Cable Impedance. [Online]. Available: http://www.epanorama.net/documents/wiring/cable_impedance.html
- [10].RF Coaxial Cables - Madison Cable – Tyco Electronics. [Online]. Available: <http://www.madisoncable.com/RFCoaxialCables.asp>
- [11].Baluns in theory. [Online]. Available: <http://radioworks.com/nbalun.html#misconceptions>
- [12].IEEE Transactions on Antennas and Propagation, Vol. 52, No. 7, July 2004
- [13].Baluns. [Online]. Available: <http://www.ycars.org/presentations/baluns.ppt#1>
- [14].David M. Pozar, Department of Electrical and Computer Engineering, University of Massachusetts at Amherst, Microwave and RF Design of Wireless Systems
- [15].Notes on LPDA stubs. [Online]. Available: <http://www.cebik.com/lpda/lst.html>

Appendices

A.1

The Friis equation indicates that the received power (P_r) is inversely proportional to the square of the distance (R) from the transmitter. [7]

$$P_r = \left(\frac{G_t G_r \lambda^2}{(4\pi R)^2} \right) P_t \quad \text{Watts}$$

G_t and G_r are the gains of the transmitting and receiving antennas respectively, λ is the wavelength and P_t is the transmitted power.

A.2

$$\text{Percentage bandwidth} = \left(\frac{f_H - f_L}{f_C} \right) 100$$

f_H = upper frequency, f_L = lower frequency and f_C = centre frequency

A.3

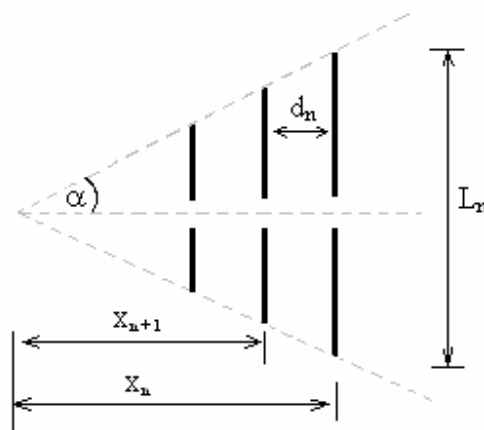

Figure A.3

Elements X_n and X_{n+1} form congruent triangles and from equation (2.1.2), $L_n = d_n/2\sigma$. If we only consider the top triangle then $L_n = d_n/4\sigma$. From trigonometry, α is given by

$$\alpha = \tan^{-1}\left(\frac{d_n}{X_n 4\sigma}\right)$$

And $d_n = X_n - X_{n+1}$ or $d_n = X_n - X_n\tau$ since from equation (2.1.1), $X_{n+1} = X_n\tau$. Therefore substituting for d_n , we obtain α as

$$\begin{aligned}\alpha &= \tan^{-1}\left(\frac{X_n(1 - \tau)}{X_n 4\sigma}\right) \\ &= \tan^{-1}\left(\frac{1 - \tau}{4\sigma}\right)\end{aligned}$$

A.4

The longest element is made half the wavelength corresponding to the lower frequency of interest having wavelength (λ_{\max}). The distance between the longest and shortest dipole (L) is derived as follows.

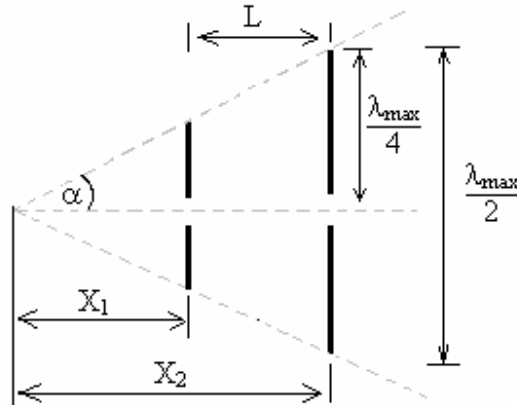

Figure A.4

The shortest element has length $(\lambda_{\max}/4)\tau^{N-1}$ where τ is the length ratio between the adjacent dipoles. From trigonometry, we obtain

$$X_2 = \frac{\lambda_{\max}}{4} \cot \alpha$$

$$X_1 = \frac{\lambda_{\max}}{4} \tau^{N-1} \cot \alpha$$

$$= \frac{\lambda_{\max}}{4} \frac{1}{B_s} \cot \alpha \quad (\text{since } B_s = \tau^{1-N} \text{ [8]})$$

Finally

$$L = X_2 - X_1$$

$$\text{or } L = \frac{\lambda_{\max}}{4} \left(1 - \frac{1}{B_s}\right) \cot \alpha$$

A.5

Referring to figure 2.1b, $X_N = X_1 \tau^{N-1}$ and therefore

$$\frac{X_N}{X_1} = \tau^{N-1}$$

$$\text{And } \log\left(\frac{X_N}{X_1}\right) = \log \tau^{N-1}$$

$$\log\left(\frac{X_N}{X_1}\right) = (N-1) \log \tau$$

$$\text{or } N = 1 + \frac{\log B_s}{\log (1/\tau)}$$

A.6

Insertion loss (dB) = power available from source (dB) – power delivered to load (dB)

[14]

Appendix B

RF Transformer (TCN1-23)



Features

- Wideband, 1200 to 2200 MHz
- Miniature size, 0.12 inch × 0.06 inch × 0.037 inch
- LTCC construction
- Low cost
- 50 Ω

Maximum Ratings

- Operating temperature -55°C to 100°C
- Storage temperature -55°C to 100°C
- Input RF power ** 5 W

** From 85°C derate linearly to 2.5 W at 100°C

Pin Connections

- Primary dot 4
- Primary (GND) 2,5
- Secondary dot 1
- Secondary 6
- Not used 3

Electrical Specifications ($T_{AMB} = 25^{\circ}C$)

Ω Ratio	Frequency (MHz)	Insertion Loss (dB)	Phase Unbalance (Deg.) Typ.	Amplitude Unbalance (dB) Typ.
1	1300 - 2300	0.7	5.0	0.7
	1800 - 2000	0.6	4.0	0.5

* Insertion loss is referenced to mid-band loss, 0.8 dB

Typical Performance Data

Frequency (MHz)	Insertion Loss (dB)	Input R.Loss (dB)	Amplitude Unbalance (dB)	Phase Unbalance (Deg.)
1300.00	0.91	15.33	0.89	1.52
1500.00	0.91	16.32	0.60	1.46
1600.00	0.91	17.14	0.50	1.81
1700.00	0.91	18.31	0.44	2.34
1800.00	0.92	19.68	0.41	3.09
1900.00	0.93	21.20	0.43	3.82
2000.00	0.95	22.85	0.50	4.57
2100.00	0.97	24.40	0.60	5.34
2200.00	1.00	25.70	0.75	6.05
2300.00	1.04	26.43	0.95	6.61

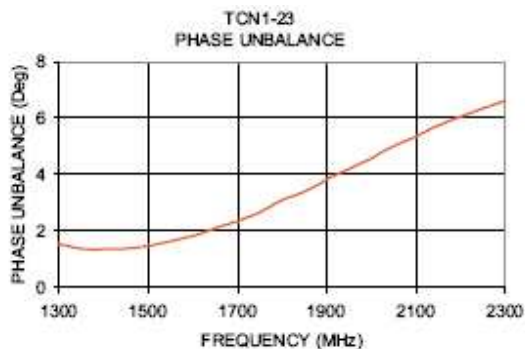
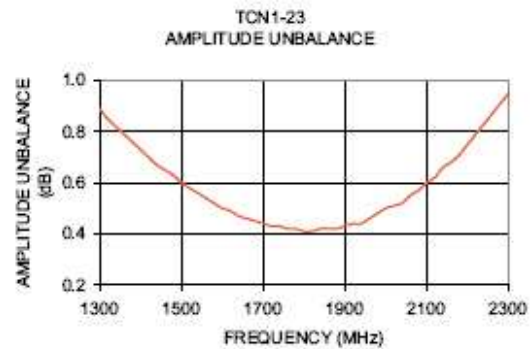
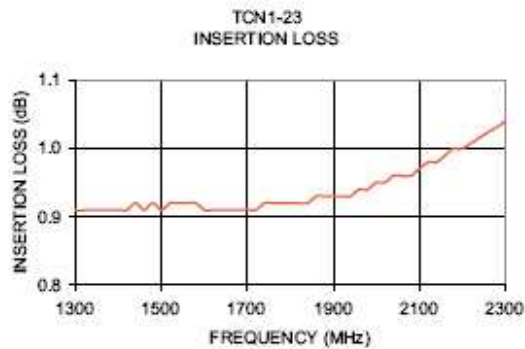

This RF transformer is available from the Mini-Circuits. All the information about it was obtained from the webpage: [http:// www.minicircuits.com](http://www.minicircuits.com)

